

DOOR TEMPLATE

SUITS 33mm TO 45mm THICK DOORS

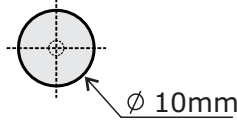

Mark and drill holes from both sides of the door.

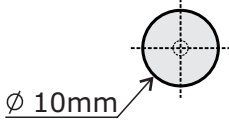
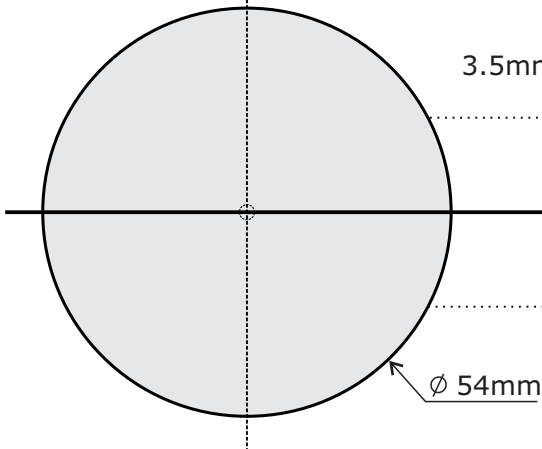
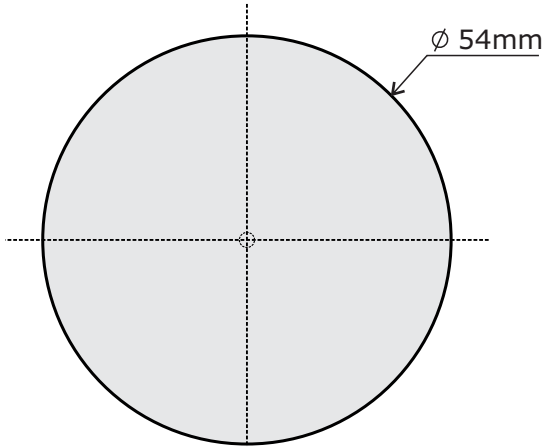

60mm BACKSET

Chisel
3.5mm deep

FOLD HERE

↑
TOP
of door

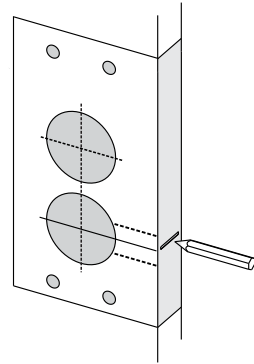

Position on
Door Edge

Mark \varnothing 25mm hole at
centre of door edge.

LATCH HEIGHT

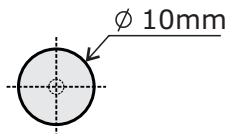
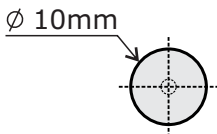

LEMAAR

ENTRY PRO 3.0

DOOR TEMPLATE

SUITS 33mm TO 45mm THICK DOORS

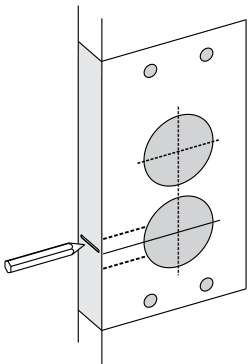

FOLD HERE

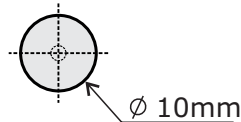
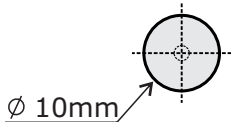

$\varnothing 54\text{mm}$

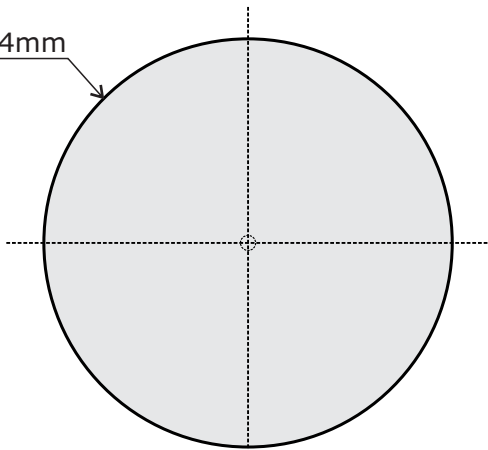

60mm BACKSET

Chisel
3.5mm deep

Mark $\varnothing 25\text{mm}$ hole at
centre of door edge.

LATCH HEIGHT

$\varnothing 54\text{mm}$

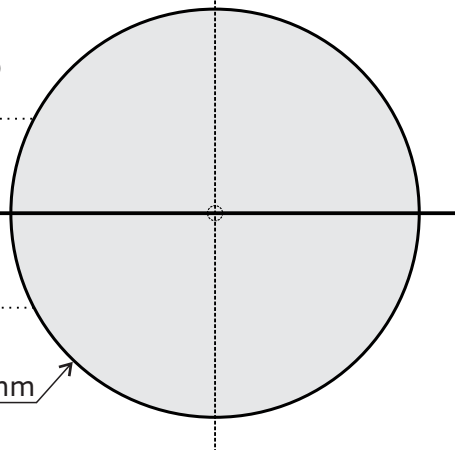

$\varnothing 10\text{mm}$

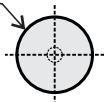

$\varnothing 10\text{mm}$

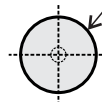

Mark and drill holes from both sides of the door.