

Privacy Set Installation Instructions

1: Mark Door

- Fold and apply installation template to edge of door and mark centre of door edge as indicated on the template at the desired latch height.
- Mark centre hole on the door face through guide on template for 60mm (2 3/8") backset.
- Mark the two through fix holes and the Privacy Pin Hole on the door face

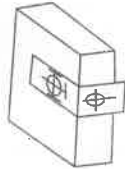

2: Drill holes

- Drill 25mm (1") hole in edge of door to the depth of the entire Latch.
- Drill through door face as marked two vertical fixings and one horizontal 6.5mm (1/4") holes through the door.
- Drill through door face as marked one 28mm (1 1/8") to 35mm (1 5/8") hole through the door at 60mm (2 3/8") backset. It is recommended that a pilot hole be drilled through the door first.

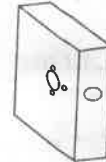

3: Install Latch

- Insert latch in hole. Position the face plate parallel to door edge. Mark outline of the face plate and remove latch.



- With a Chisel, mortise the latch faceplate into the edge of the door until it is flush with door edge.



- Install Latch into position in door edge. Drill and install fixing screws.



- Integral Privacy Latch Assembly

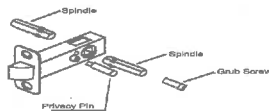

4: Install Lever Set

- Insert the two spindles ONE from either side into the latch. Insert grub screw through one of the spindles and using the allen key tighten the grub screw into the opposing spindle.

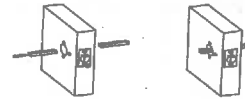

- Remove the outer rosettes from the levers. Position the levers to both sides of the door. Insert the fixing posts through the rosettes on either side of the door. Insert the fixing screw from the opposing side and screw up tight.

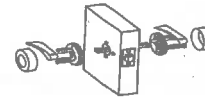

- Screw Privacy Locking Pin into position in the latch. Ensure that the levers from both sides when turned retracts the latch. While the door is in the open position push the privacy locking pin in and check that the outside lever is locked and when the inside lever is turned that it unlocks the outside lever. Replace outer rosettes

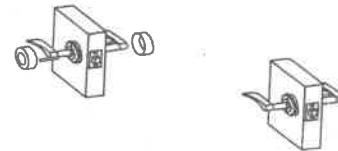

Installation Template for Lemaar Integral Privacy Latch.

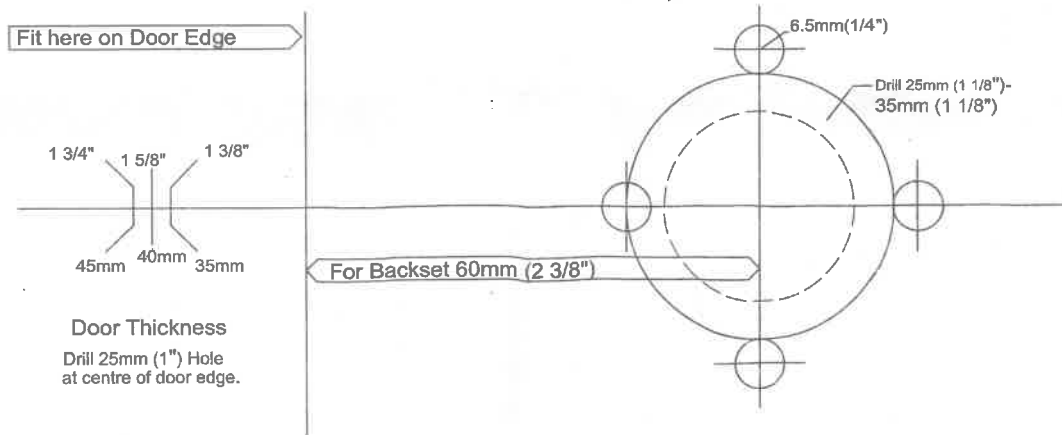

Privacy Set Installation Instructions

5: Install Strike Plate

- A. Close door mark centre line of the bolt on jamb.
Open door and extend mark to the door stop.
Measure back from door stop half the door thickness and mark.



- B. Drill 25mm (1") hole, 12 to 15mm (5/8") deep at centre mark on Jamb.



- C. Align strike plate and mark out line chisel 3mm (1/8") deep or until strike plate is flush with jamb.

